

### Before assembly

- We recommend that time is taken to read the instructions before starting assembly, then follow the easy step by step guide. The instruction sheet is only a guide to the assembly. Certain items may not be shown to scale.
- Check all components prior to assembly
- This product should be assembled by no less than two people.
- Never attempt to erect the assembly in high winds.
- Drill components where indicated.



### Recommended tools for assembly

- Cross head screw driver
- Hammer
- Sharp knife
- Drill
- 3mm diameter drill bit
- 6mm diameter drill bit
- 10mm spanner
- Spirit level
- Silicon sealant
- Step ladder

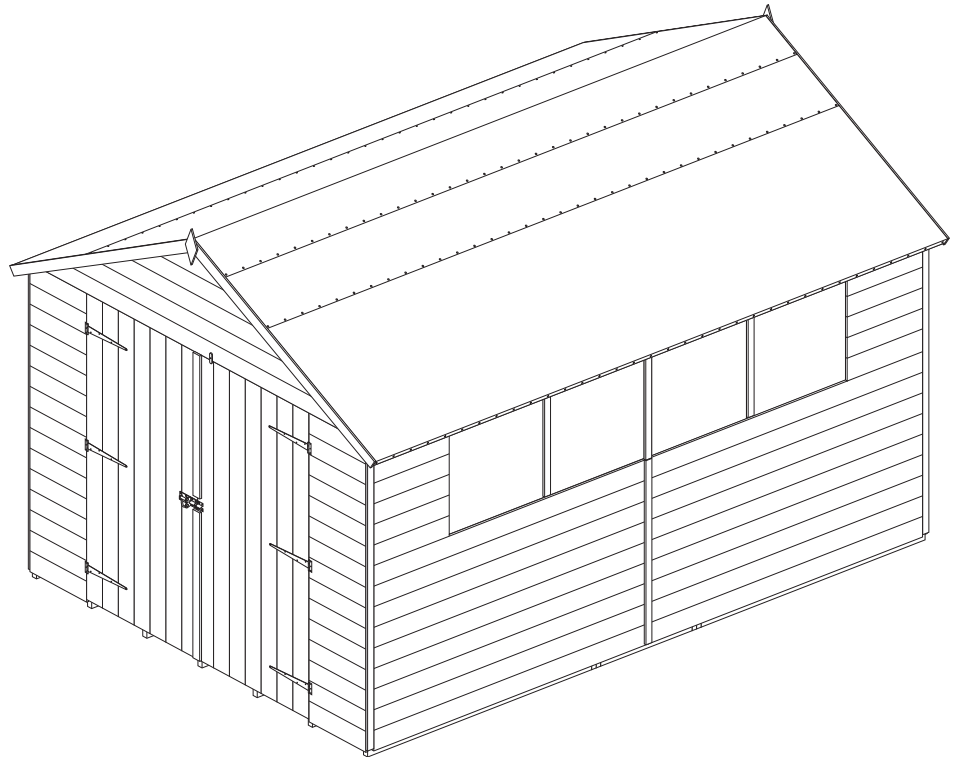

| No. | Components                           | Qty. |
|-----|--------------------------------------|------|
| 1   | Large floor section                  | 2    |
| 2   | Small floor section                  | 1    |
| 3   | Left-handed window side panel        | 1    |
| 4   | Right-handed window side panel       | 1    |
| 5   | Plain side panel                     | 2    |
| 6   | Door end panel                       | 1    |
| 7   | Plain end panel                      | 1    |
| 8   | Apex panel                           | 2    |
| 9   | Left-handed roof panel               | 2    |
| 10  | Centre roof panel                    | 2    |
| 11  | Right-handed roof panel              | 2    |
| 12  | Coverstrips (12 x 40 x 1715mm)       | 5    |
| 13  | Short coverstrip (12 x 40 x 1030mm)  | 1    |
| 14  | Acrylic windows (610 x 565mm)        | 4    |
| 15  | Wooden window beading (Length=560mm) | 8    |
| 16  | Wooden window beading (Length=610mm) | 4    |
| 17  | Felt roll (4m)                       | 4    |
| 18  | Door weather strip (12 x 48 x 800mm) | 1    |
| 19  | Door weather strip (12 x 48 x 830mm) | 1    |
| 20  | Bargeboard                           | 4    |

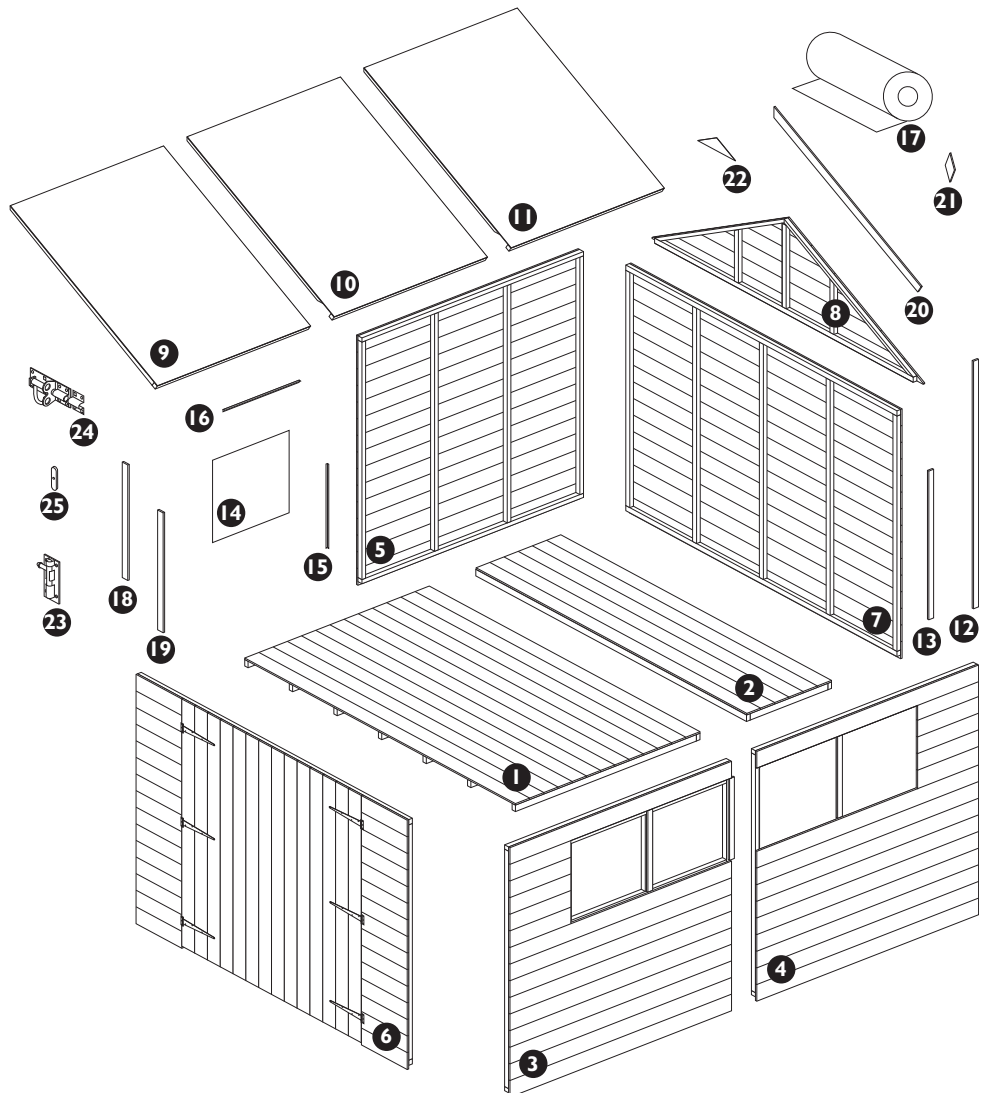

| No. | Fixing Kit             | Qty. |
|-----|------------------------|------|
| 21  | finial                 | 2    |
| 22  | Roof gussets           | 12   |
| 23  | Tower bolts            | 2    |
| 24  | Padbolt                | 1    |
| 25  | Turn button            | 1    |
| 26  | 50mm Coach bolts       | 4    |
| 27  | 6mm Nut                | 4    |
| 28  | 6mm Washer             | 4    |
| 29  | 63mm screws            | 16   |
| 30  | 50mm screws            | 36   |
| 31  | 38mm screws            | 114  |
| 32  | 22mm screws            | 13   |
| 33  | 19mm round head screws | 12   |
| 34  | 65mm nails             | 10   |
| 35  | 50mm nails             | 16   |
| 36  | 25mm nails             | 36   |
| 37  | 10mm felt nails        | 200  |

## 1. Floor

Prepare a level area for the shed to sit. Join the 3 floor sections together using 6 x 50mm screws as shown below. Attach with nails 8 wooden or similar bearers of size 50 x 50 x 2366mm (not supplied in kit) to the floor section.



It is recommended to drill pilot holes in the side panel framing with a 3mm drill bit before assembly.

To "VALIDATE" the guarantee, this item should be erected on 50mm x 50mm treated wooden or similar bearers (**These are not supplied with the kit**). Ground contact must be avoided.

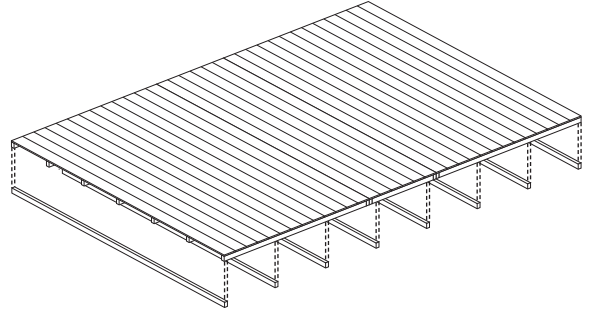
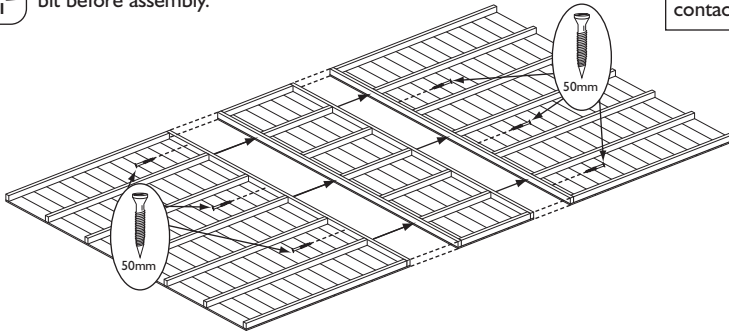

## 2. Fixing the wall panels together

Position the back panel and a plain side panel on the floor as shown. Note how the panel frames sit on the floor with the panel cladding overhanging the floor edge. Ensure square and secure using 3 x 50mm screws, screw through the side panel into the frame of the back panel. In the same way attach the right-handed window panel to the other end of the back panel as shown. Place the second plain side panel next to the first plain side panel, ensure level and secure them together using 3 x 50mm screws through the frame of the second plain panel into the frame of the first. Attach the left-handed window panel and door end panel in the same way.



It is recommended to drill pilot holes in the side panel framing with a 3mm drill bit before assembly.

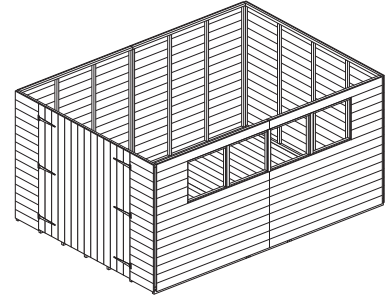
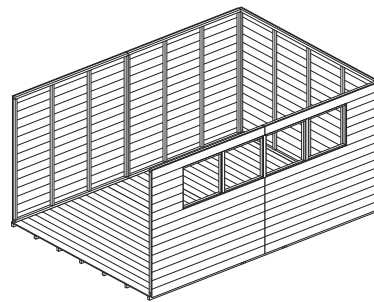
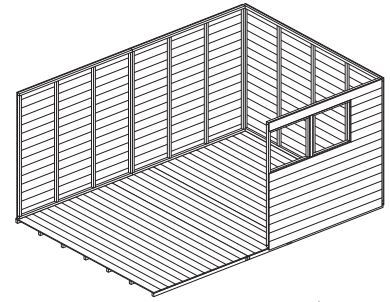
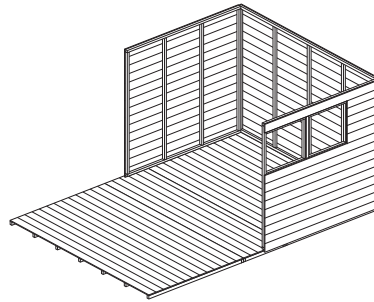
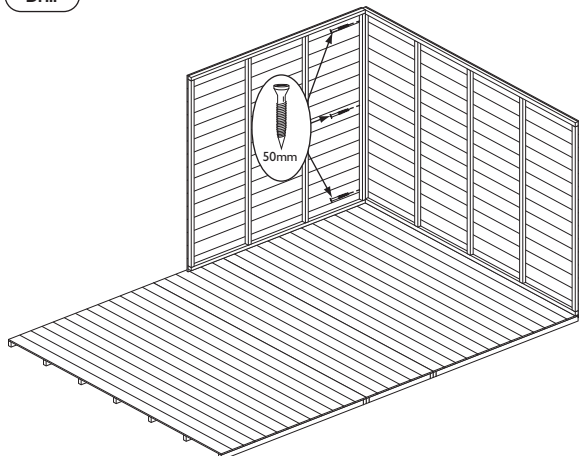

Side panel

Back panel



Panel frames rest on floor.

Panel cladding overhangs floor edge.

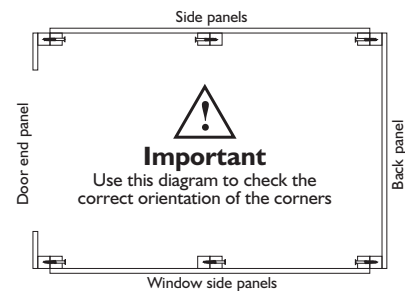

## 3. Attaching apex panels

Place an apex panel on top of the back panel, make sure the bottom shiplap board of the apex panel fits correctly into the top Shiplap board of the back panel. Secure by using 8 x 63mm screws, screw up through the top frame of the back panel into the bottom frame of the apex panel. Repeat for front apex panel.



It is recommended to drill pilot holes in the front and back panel framing with a 3mm drill bit before assembly.

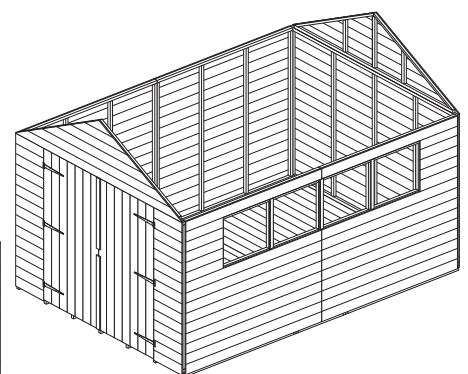
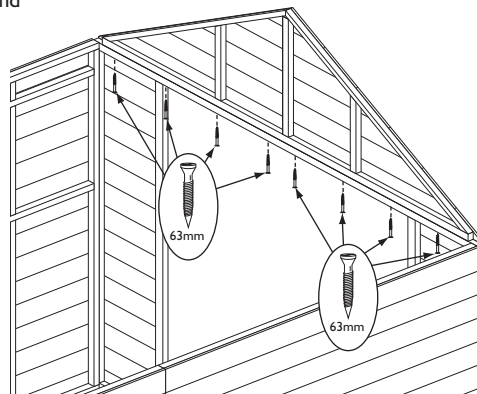
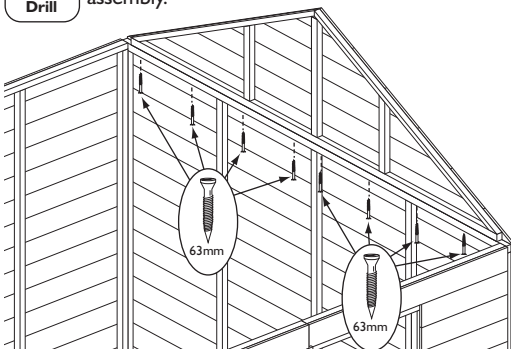

#### 4. Securing the walls to the floor

Ensure the panels are sitting square on the floor. For the front and back panels secure using 5 x 65mm nails per panel, through the panel frames and floor into the floor joists. For the side panels secure in the same way using 4 x 50mm nails per panels.

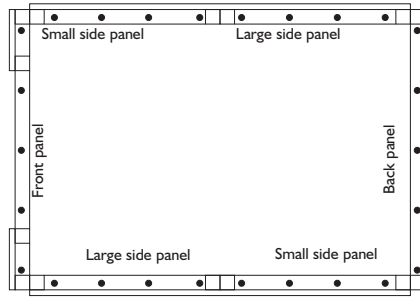
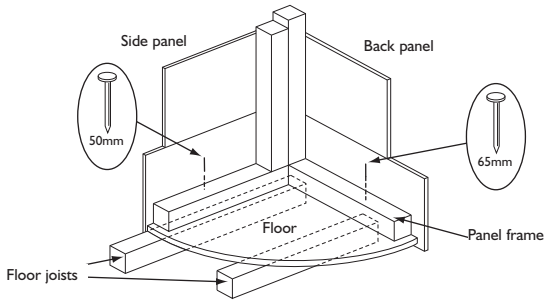

#### 5. Roof assembly

As shown below construct a roof section using a left, a right and a centre roof panel, screw together using 3 x 50mm screws for each of the two joins. Assemble a second roof section in the same way. Lift the roof sections into place. Ensure the upper edge of both roof sections meet evenly at the apex. Screw the roof down using 16 x 38mm screws per roof section, screw through the roof panel into the framing of the apex panels and the side panels as shown. From inside the building fix the gussets to the rafters as shown using 4 x 38mm screws per gusset.

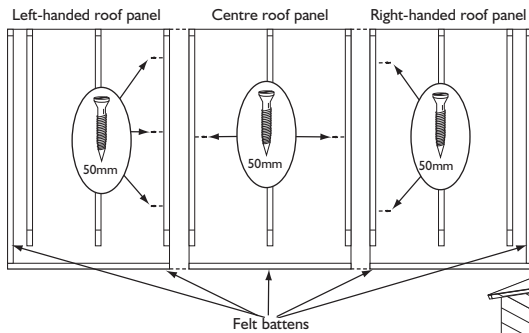

It is recommended to drill pilot holes in the roof panel framing with a 4mm drill bit before assembly.

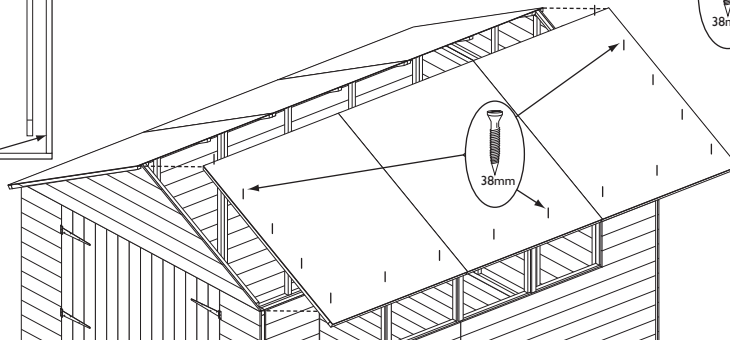
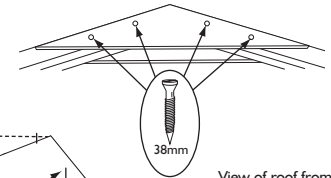

View of roof from inside building

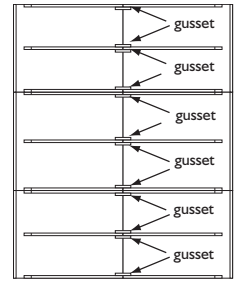

#### 6. Felt covering

Unroll a length of roof felt and place over 1 side of the roof. Have equal overhang at the front and back of the shed and an overhang of about 45mm along the lower edge. Fold down the felt along the lower edge and secure to the felt batten using 30 x 10mm felt nails evenly spaced. Tension the felt over the roof and secure along the upper edge using 10 x 10mm felt nails. Repeat this with a second piece of felt on the other side of the roof. Unroll and place a third piece of felt so that it overlaps the first and also folds over the roof ridge. Fix the edge overlapping the first felt piece using 30 x 10mm felt nails evenly spaced, tension the felt and attach the side over the roof ridge using 10 x 10mm felt nails evenly spaced. Position the fourth felt piece in the same way on the other side of the roof and attach both edges using 30 x 10mm felt nails per edge. Dress down the felt at the front and back and secure to the felt battens using 10 x 10mm felt nails at each end. when all felt pieces are secured in position trim off excess felt.

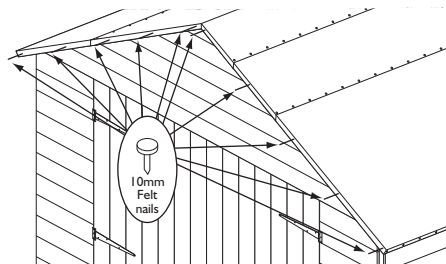
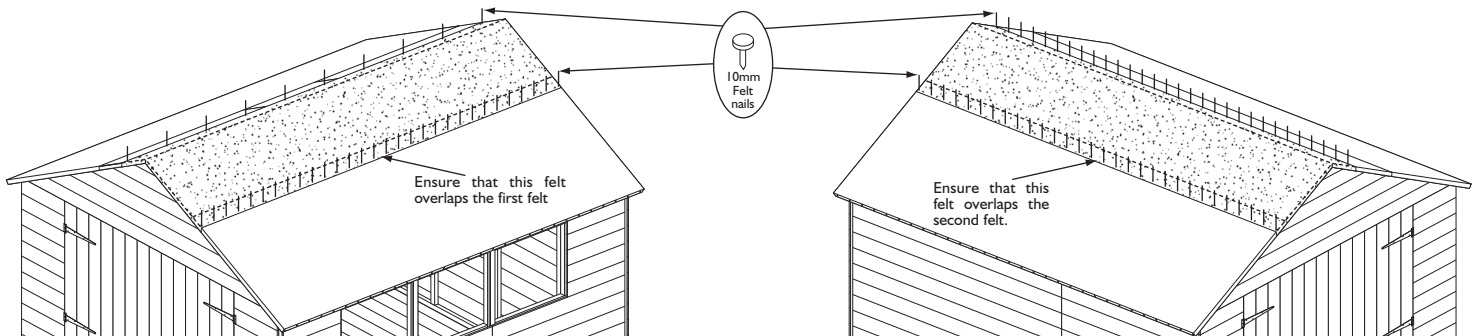
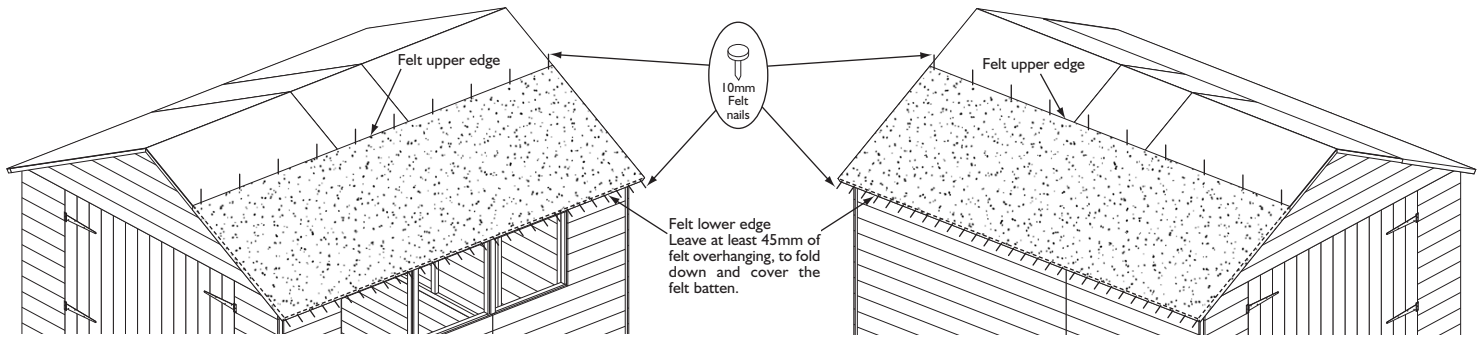

## 7. Coverstrips, bargeboards and finial

Fit a coverstrip into each corner, attach using 3 x 38mm screws per strip. Position a fifth coverstrip over the join of two plain side panels and attach with 3 x 38mm screws. Attach the short coverstrip over the join of the two window side panels. Secure the bargeboards at the front so that the top edge is flush with the roof line and the two boards meet evenly at the apex secure using 3 x 38mm screws per board. Repeat for the bargeboards on the back. On the front attach a finial centrally over the join between the bargeboards use 2 x 38mm screws. Repeat for the finial on the back.



Drill

It is recommended to drill pilot holes for all screws with a 3mm drill bit before assembly.

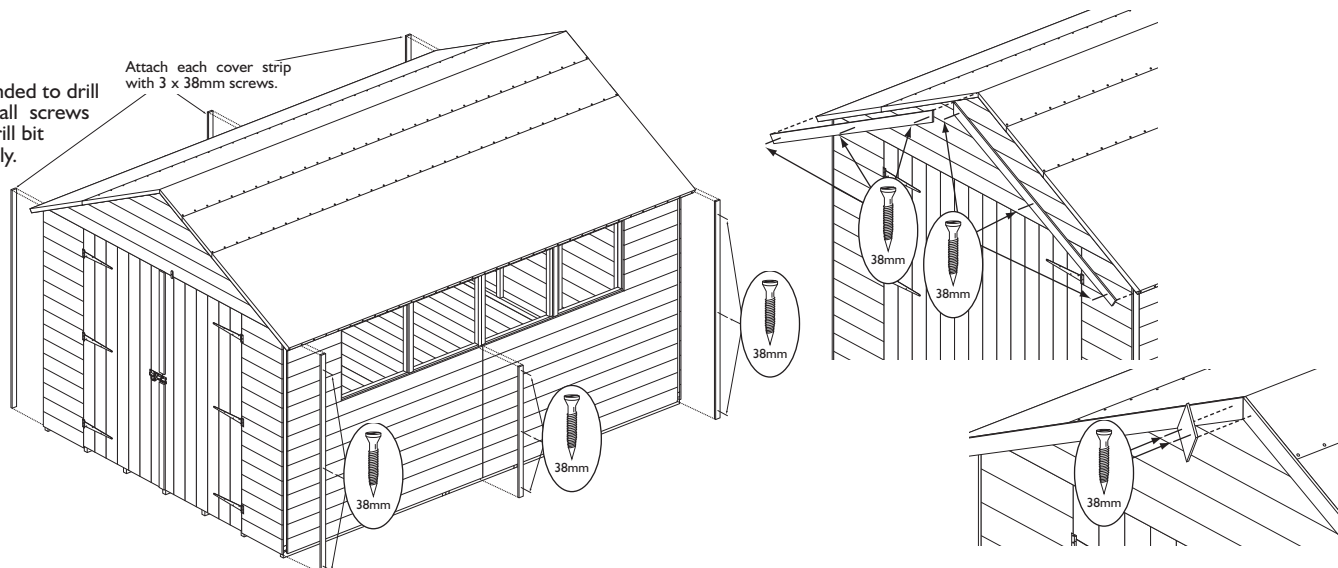

## 8. Door fittings and windows

On the inside of the right-hand door secure the tower bolts to the mounting blocks using 4 x 19mm round head screws per bolt. With the doors shut, position a door coverstrip so it overlaps both doors and is flush at the top of the doors, secure only to left-hand door using 3 x 22mm screws. In the same way fix the other door coverstrip flush to the bottom of the door. Fit the padbolt to the left door between the two coverstrips using 4 x 22mm screws and 2 x 50mm coach bolts, nuts and washers. It will be necessary to drill holes for the coach bolts using a 6mm diameter drill bit. Fit the catch plate to the right door using 2 x 22mm screws and 2 x 50mm coach bolts, nuts and washers, as shown below. Position the turn button just above the left-hand door secure to the apex panel using 1 x 22mm screw. To fit the windows it is recommended that a waterproof sealant is applied around the edge of the glazing before fitting. From the outside of the building fit the acrylic window into the plastic strip, fix the window in place with the window beading strips, 560mm at each side and 610mm at the top secure using 3 x 25mm nails per beading strip.. Repeat for the other three windows.

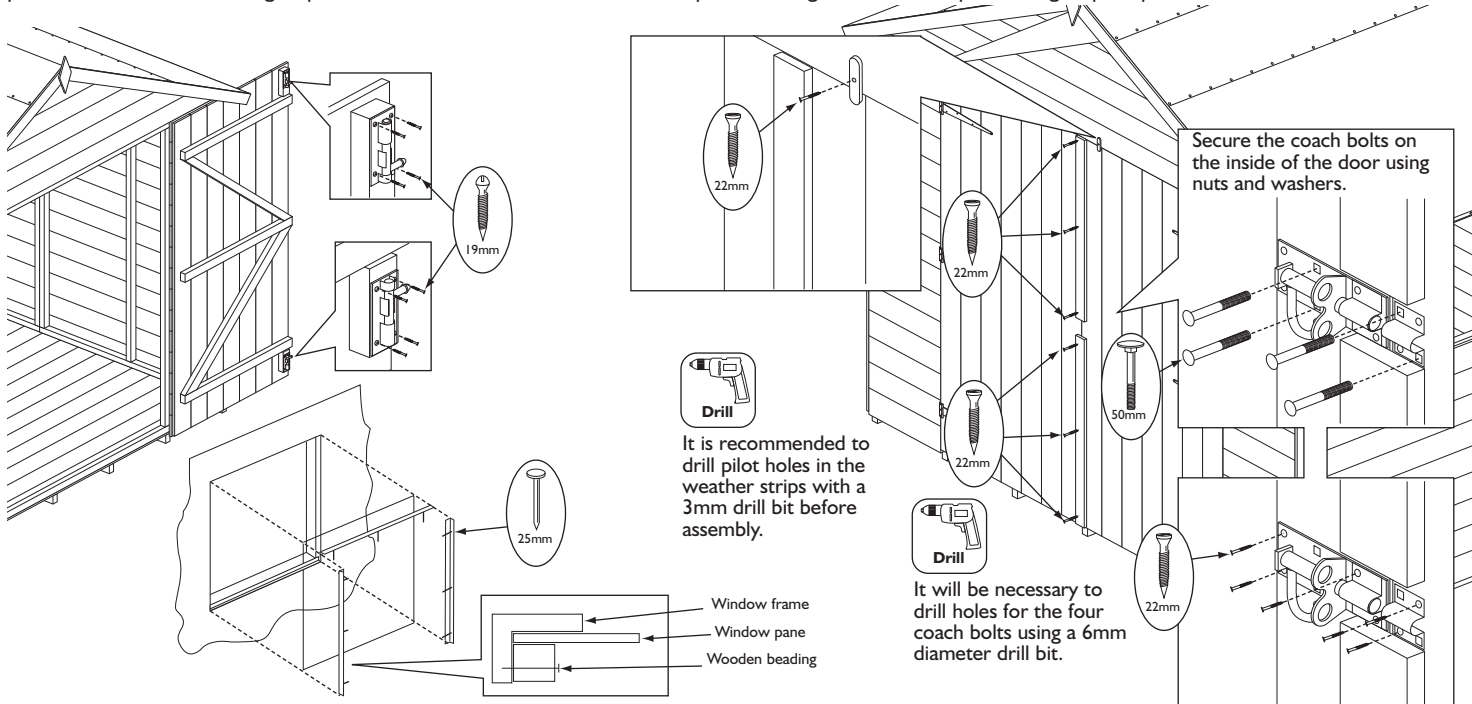

## Important information - retain for future reference

Shiplap buildings come ready stained but this is only a preparatory treatment. To **VALIDATE** the guarantee, the building must be properly treated with a recognised external wood preserver **WITHIN 3 MONTHS** of assembly and **RE-TREATED ANNUALLY** thereafter.

Adequate provision must be made to ensure ground contact is avoided and air is able to circulate underneath the building. Placing the building on a concrete pad or slab base is acceptable provided that the building is not allowed to sit in pooled water during wet conditions. If the building is to sit on soil or grass it **MUST** be erected on pressure treated wooden 50mm x 50mm or similar bearers (**These are not supplied in the kit**). Rowlinson Garden Products recommend using pressure treated bearers with all buildings on any type of base.

### Timber Information.

As timber is a natural material, there are certain weather conditions that may affect the materials properties. In times of excessive dry spells the material may lose some of its internal moisture causing a certain degree of shrinkage on a panel and in periods of excessive rain there will be a certain amount of swelling throughout the wooden panels. This process can not be avoided. If you have problems with certain boards shrinking in dry spells try to decrease the amount of direct sunlight on the building or the amount of air passing over the building. During hot spells spray water directly onto the panels with the aid of a garden hose.

If in doubt of any aspect regarding the assembly, use or safety of your building please contact us :

**Help Line: (Normal Office Hours) 01829 261 121**

**Email: support@rowgar.co.uk**

ROWLINSON GARDEN PRODUCTS LIMITED  
Green Lane  
Wardle Nr. Nantwich  
Cheshire  
CW5 6BN  
[www.rowgar.co.uk](http://www.rowgar.co.uk)

We constantly improve the quality of our products, occasionally the components may differ from the components shown and are only correct at time of printing. We reserve the right to change the specification of our products without prior notice.

2015 © Rowlinson Garden Products Ltd